

Lokalisierungsformate

Florian Sachse
Pass Engineering GmbH

Windows RC-Script

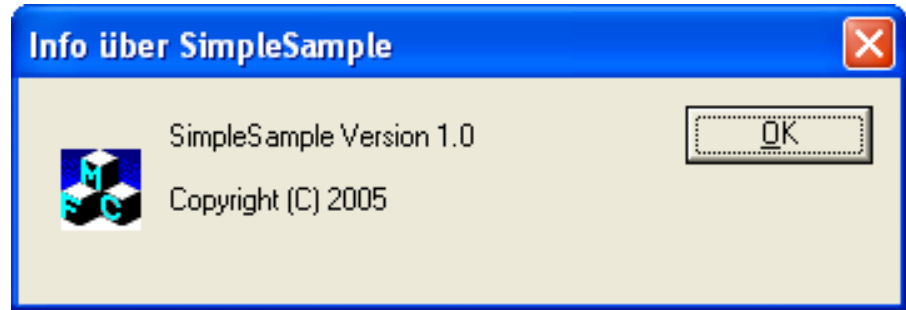

```
IDD_ABOUTBOX DIALOG DISCARDABLE 0, 0, 235, 55
STYLE DS_MODALFRAME | WS_POPUP | WS_CAPTION |
    WS_SYSMENU
CAPTION "Info über SimpleSample"
FONT 8, "MS Sans Serif"
BEGIN
    ICON IDR_MAINFRAME, IDC_STATIC, 11,17,20,20

    LTEXT "SimpleSample Version 1.0",
        IDC_STATIC,40,10,119,8,SS_NOPREFIX

    LTEXT "Copyright (C) 2005", IDC_STATIC,
        40,25,119,8

    DEFPUSHBUTTON "&OK", IDOK,178,7,50,14,WS_GROUP
END
```

Windows RC-Script

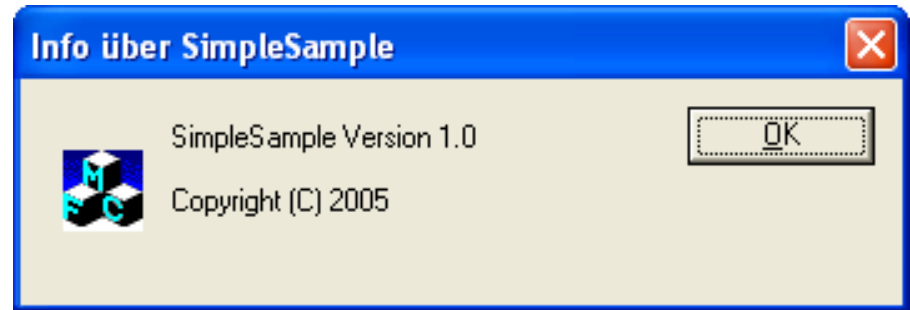

```
IDD_ABOUTBOX DIALOG DISCARDABLE 0, 0, 235, 55
STYLE DS_MODALFRAME | WS_POPUP | WS_CAPTION |
    WS_SYSMENU
CAPTION "Info über SimpleSample"
FONT 8, "MS Sans Serif"
BEGIN
    ICON IDR_MAINFRAME, IDC_STATIC, 11,17,20,20

    LTEXT "SimpleSample Version 1.0",
        IDC_STATIC,40,10,119,8,SS_NOPREFIX

    LTEXT "Copyright (C) 2005", IDC_STATIC,
        40,25,119,8

    DEFPUSHBUTTON "&OK", IDOK,178,7,50,14,WS_GROUP
END
```

Windows RC-Script

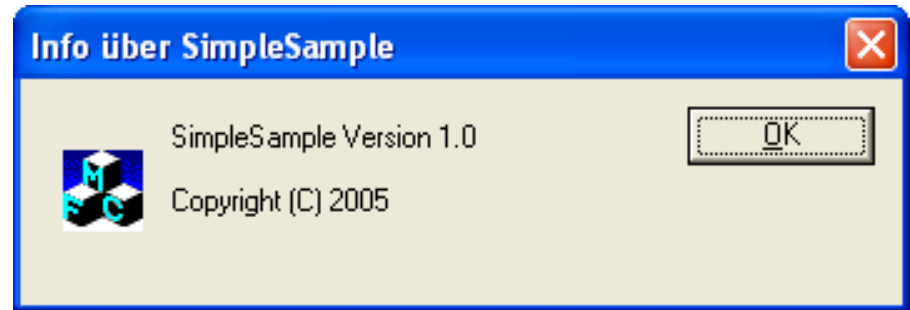

```
IDD_ABOUTBOX DIALOG DISCARDABLE 0, 0, 235, 55
STYLE DS_MODALFRAME | WS_POPUP | WS_CAPTION |
WS_SYSMENU
CAPTION "Info über SimpleSample"
FONT 8, "MS Sans Serif"
BEGIN
    ICON IDR_MAINFRAME, IDC_STATIC, 11,17,20,20

    LTEXT "SimpleSample Version 1.0",
        IDC_STATIC,40,10,119,8,SS_NOPREFIX

    LTEXT "Copyright (C) 2005", IDC_STATIC,
        40,25,119,8

    DEFPUSHBUTTON "&OK", IDOK,178,7,50,14,WS_GROUP
END
```

Windows RC-Script

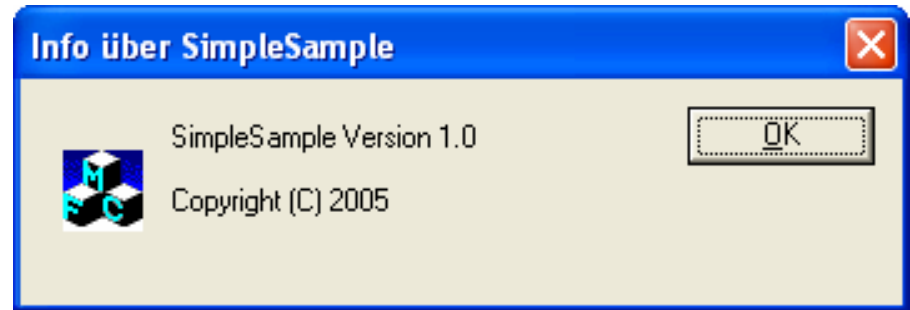

```
IDD_ABOUTBOX DIALOG DISCARDABLE 0, 0, 235, 55
STYLE DS_MODALFRAME | WS_POPUP | WS_CAPTION |
WS_SYSMENU
CAPTION "Info über SimpleSample"
FONT 8, "MS Sans Serif"
BEGIN
    ICON IDR_MAINFRAME, IDC_STATIC, 11,17,20,20

    LTEXT "SimpleSample Version 1.0",
        IDC_STATIC,40,10,119,8,SS_NOPREFIX

    LTEXT "Copyright (C) 2005", IDC_STATIC,
        40,25,119,8

    DEFPUSHBUTTON "&OK", IDOK,178,7,50,14,WS_GROUP
END
```

Windows RC-Script

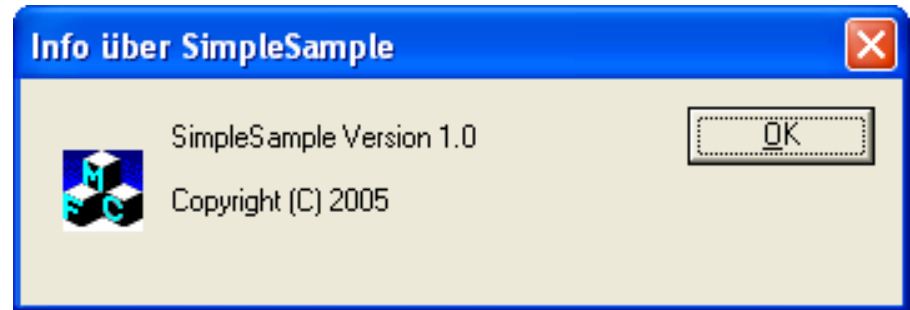

```
IDD_ABOUTBOX DIALOG DISCARDABLE 0, 0, 235, 55
STYLE DS_MODALFRAME | WS_POPUP | WS_CAPTION |
WS_SYSMENU
CAPTION "Info über SimpleSample"
FONT 8, "MS Sans Serif"
BEGIN
    ICON IDR_MAINFRAME, IDC_STATIC, 11,17,20,20

    LTEXT "SimpleSample Version 1.0",
        IDC_STATIC, 40,10,119,8, SS_NOPREFIX

    LTEXT "Copyright (C) 2005", IDC_STATIC,
        40,25,119,8

    DEFPUSHBUTTON "&OK", IDOK, 178,7,50,14, WS_GROUP
END
```

String Tables

```
STRINGTABLE DISCARDABLE
BEGIN
    AFX_IDS_SCRESTORE "Stellt das Fenster in seiner normalen Größe wieder her."
    AFX_IDS_SCTASKLIST "Aktiviert die Task-Liste."
END

STRINGTABLE DISCARDABLE
BEGIN
    AFX_IDS_PREVIEW_CLOSE "Beendet die Seitenansicht.\nSeitenansicht beenden"
END
```

Flache Windows Ressourcen

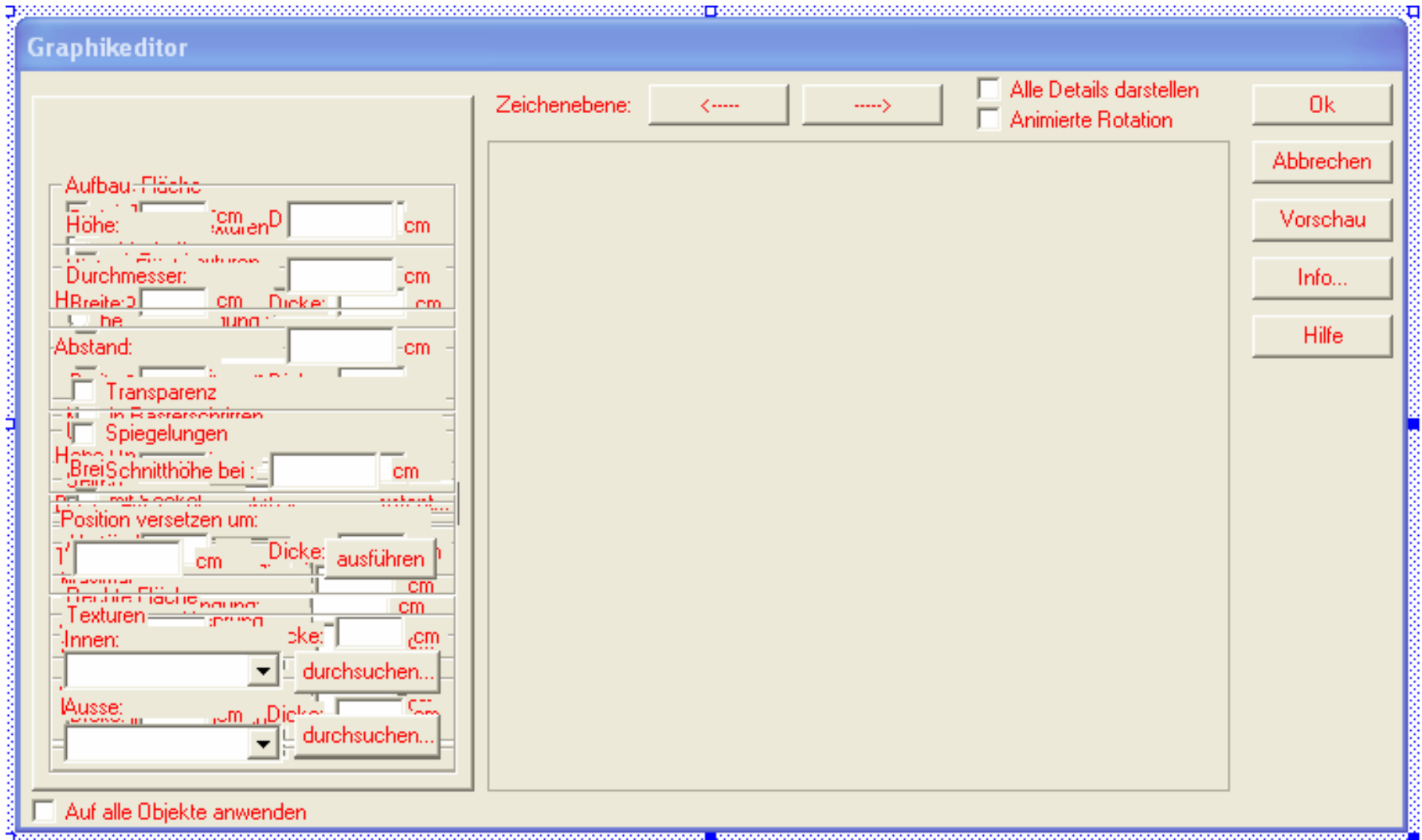

Platzhalter, Escape-Sequenzen, Tags I

```
IDD_ABOUTBOX DIALOG DISCARDABLE 0, 0, 235, 55
STYLE DS_MODALFRAME | WS_POPUP | WS_CAPTION | WS_SYSMENU
CAPTION "Meyer && Söhne"
FONT 8, "MS Sans Serif"
BEGIN
    ICON IDR_MAINFRAME, IDC_STATIC, 11,17,20,20

    LTEXT "SimpleSample Version 1.0",
        IDC_STATIC,40,10,119,8,SS_NOPREFIX

    LTEXT "Copyright (C) 2005", IDC_STATIC,
        40,25,119,8

    DEFPUSHBUTTON "&OK",IDOK,178,7,50,14,WS_GROUP
END

STRINGTABLE DISCARDABLE
BEGIN
    AFX_IDS_ERRMSG1 "Die Datei %s enthält %d Worte."
    AFX_IDS_ERRMSG2 "Die Datei %1 enthält %2 Worte."
    AFX_IDS_PREVIEW_CLOSE " Beendet die Seitenansicht.\nSeitenansicht beenden"
END
```



'&' ist ein **Tag** und legt die Zugriffstaste fest

'&' kann nicht für sich verwendet werden. '&' => '&&'

'&&' ist die **Escape-Sequenz** für '&'

...aber nicht immer (z.B. String Table)

Platzhalter, Escape-Sequenzen, Tags II

```
IDD_ABOUTBOX DIALOG DISCARDABLE 0, 0, 235, 55
STYLE DS_MODALFRAME | WS_POPUP | WS_CAPTION | WS_SYSMENU
CAPTION "Meyer && Söhne"
FONT 8, "MS Sans Serif"
BEGIN
    ICON IDR_MAINFRAME, IDC_STATIC, 11,17,20,20

    LTEXT "SimpleSample Version 1.0",
        IDC_STATIC,40,10,119,8,SS_NOPREFIX

    LTEXT "Copyright (C) 2005", IDC_STATIC,
        40,25,119,8

    DEFPUSHBUTTON "&OK",IDOK,178,7,50,14,WS_GROUP
END

STRINGTABLE DISCARDABLE
BEGIN
    AFX_IDS_ERRMSG1 "Die Datei %s enthält %d Worte."
    AFX_IDS_ERRMSG2 "Die Datei %1 enthält %2 Worte."
    AFX_IDS_PREVIEW_CLOSE "Beendet die Seitenansicht.\nSeitenansicht beenden"
END
```

- Platzhalter werden zur Laufzeit durch aktuelle Werte ersetzt
- %s und %d sind Platzhalter, die in C und C++ verwendet werden und enthalten Informationen über Typ sind aber positionssensitiv
- Es gibt auch Entwicklungsumgebungen in denen %1, %2 verwendet werden
- Auch '&' braucht Escapesequenz '&&'
- Escapesequenz für Zeilenumbruch: '\n' und für '\' ist '\\'

Dialog



Text mit japanischen (??), deutschen (äöü) und griechischen (???) Zeichen.

OK

Unicode

Western Codepage

Unicode

Japanese Codepage

Zeichensätze

A

A

A

A

K

K

K

K

Z

Z

Z

Z

0

0

0

0

9

9

9

9

?

?

?

?

Ä

Ä

Ä

啞

Ö

Ö

Ö

啞

啞

啞

蕎

蕎

蕎

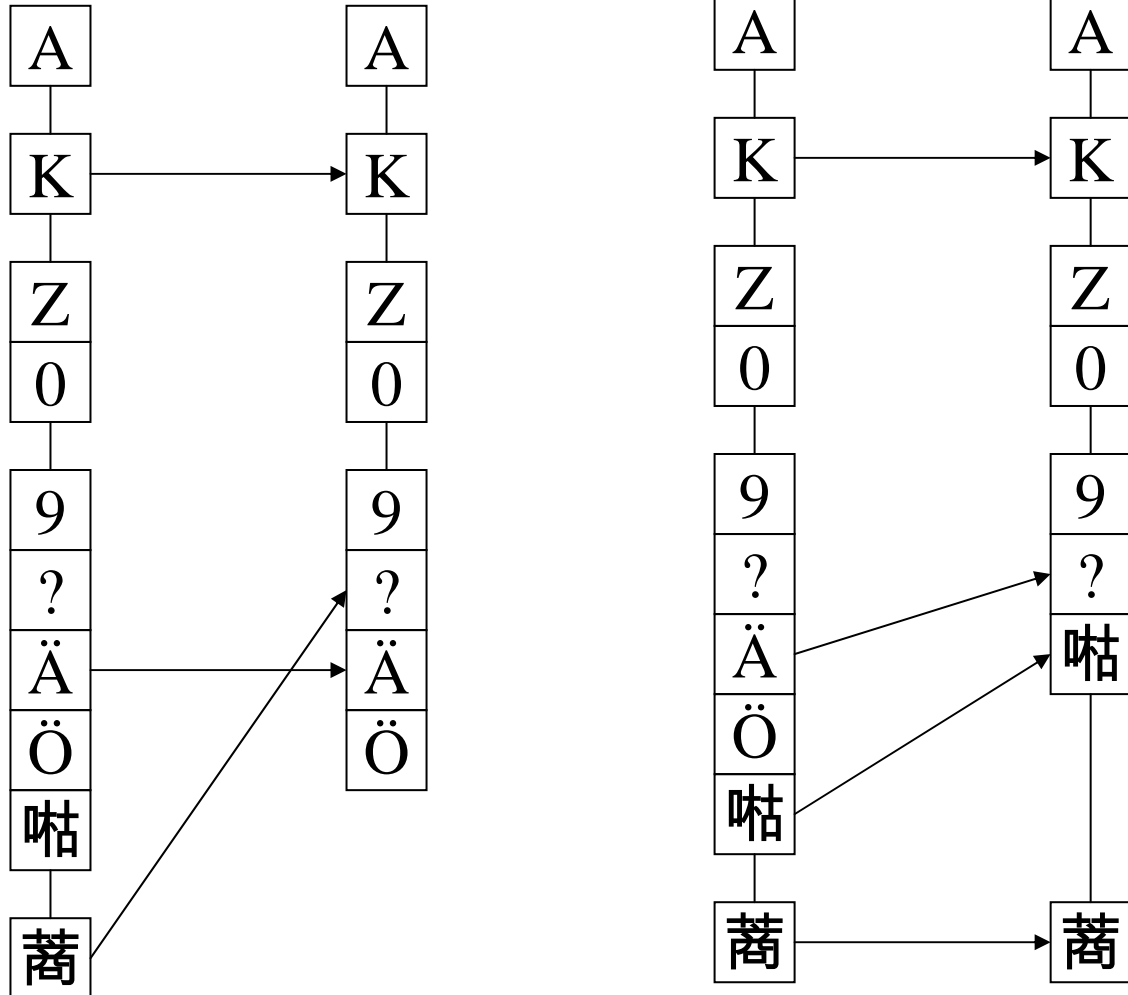

Dialog



Text mit japanischen (ㇰ), deutschen (äöü) und griechischen (ιιι) Zeichen.

OK

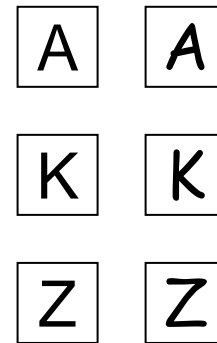
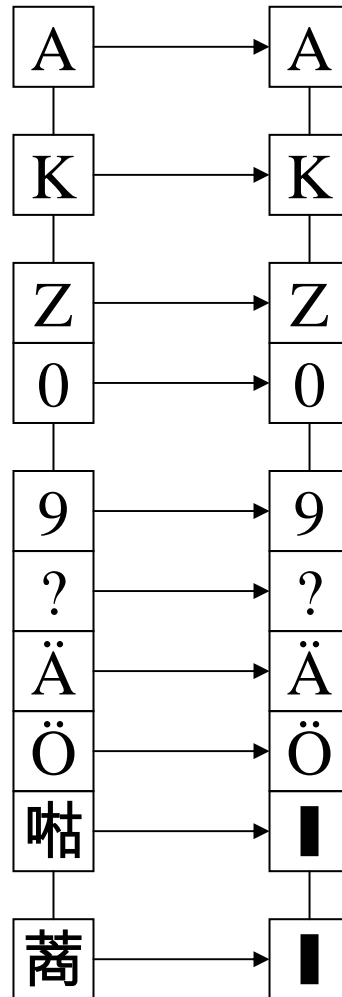

Fonts

Wenn Zeichensätze und Font passen



Diese Anwendung verwendet den Unicodezeichensatz und einen
Einen Font, der viele Skripte unterstützt.

Borland

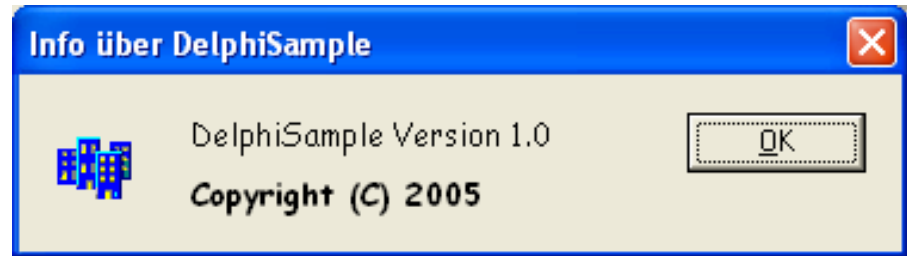

```
inherited Form3: TForm3
  Caption = 'Info über DelphiSample'
  OldCreateOrder = True
  PixelsPerInch = 96
  TextHeight = 13
  object Button1: TButton
    Left = 208
    Top = 16
    Width = 75
    Height = 25
    Caption = '&OK'
    Font.Charset = DEFAULT_CHARSET
    Font.Color = clWindowText
    Font.Height = -12
    Font.Name = 'MS Sans Serif'
    Font.Style = []
    ParentFont = False
    TabOrder = 0
  end
end
```

Borland Delphi

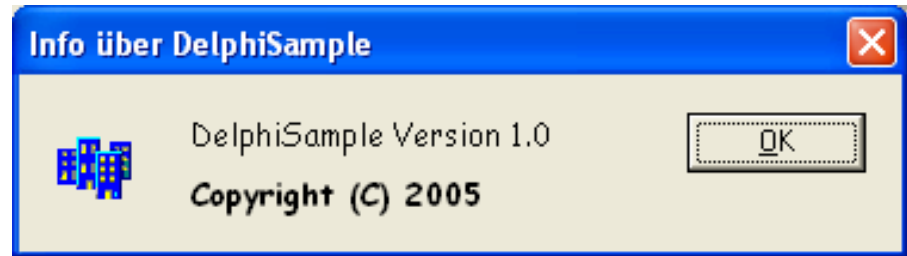

- Delphi unterstützt sogenannte Vererbung
- Delphi Ressourcen können Fonts für jede Kontrolle enthalten
- Delphi Ressourcen sind viel umfangreicher als Windows Ressourcen (hier > 800 Zeilen)
- Platzhalter, Escape-Sequenzen, Tags wie Windows
- Nicht komplett Unicode-basierend

Microsoft .NET

```
<data name="button1.Locked" type="System.Boolean, mscorlib, Version=1.0.5000.0, Culture=neutral, PublicKeyToken=b77a5c561934e089">
  <value>False</value>
</data>
<data name="button1.Anchor" ...>
  <value>Top, Left</value>
</data>
<data name="button1.BackgroundImage" ...>
  <value />
</data>
<data name="button1.Dock" ...>
  <value>None</value>
</data>
<data name="button1.Enabled" ...>
  <value>True</value>
</data>
<data name="button1.FlatStyle" ...>
  <value>Standard</value>
</data>
<data name="button1.Font" ...>
  <value />
</data>
<data name="button1.Location" ...>
  <value>256, 16</value>
</data>
<data name="button1.Size" ...>
  <value>75, 23</value>
</data>
<data name="button1.Text">
  <value>&amp;OK</value>
</data>
<data name="&gt;&gt;button1.Name">
  <value>button1</value>
</data>
<data name="&gt;&gt;button1.Type">
  <value>System.Windows.Forms.Button, System.Windows.Forms, Version=1.0.5000.0, Culture=neutral, PublicKeyToken=b77a5c561934e089</value>
</data>
```

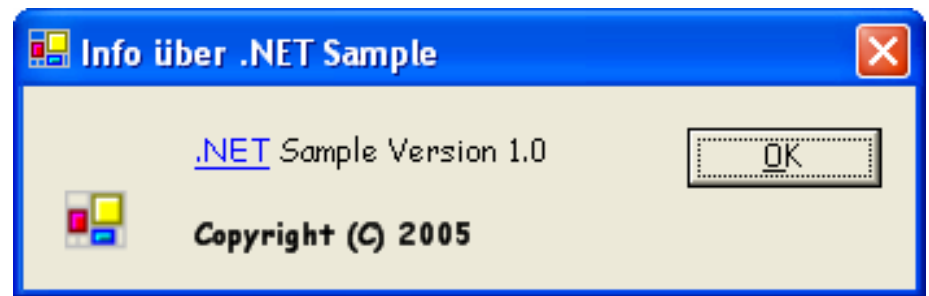

Microsoft .NET

- Sehr ausführliches Ressourcenformat (hier über 900 Zeilen)
- Tag für Zugriffstasten wie bisher aber in XML-Notation
- Platzhalter in der Form {0}, {1},... escapt mit {{ und }}
- Voll Unicode basiert
- Lokalisierung kann sehr aufwändig sein

Java



```
Dialog.Caption = Info \u00fber JavaSample
Dialog.Label1 = JavaSample 1.0
Dialog.Label2 = Copyright (C) 2005
Dialog.OKButton = OK
Dialog.OKButton_mnemonic = O
```

- Sehr einfach aufgebaut
- Spezielle Zeichen wie Umlaute können durch Escape-Sequenzen ausgedrückt werden
- Keine Informationen über Positionen
- Zugriffstasten werden anders definiert

Java II

```
public class DialogBundle extends ListResourceBundle
{
    static final Object[][] contents =
    {
        {"Caption", "Info \u00fber JavaSample"},
        {"Label1", "JavaSample 1.0"},
        {"Label2", "Copyright (C) 2005"},
        {"OKButton", "OK"},
        {"OKButton_mnemonic", "O"},
        {"Zweizeilig", "Zeile 1\nZeile 2"},
        {"TextMitPlatzhalter", "Kann Datei {0} nicht \u00f6ffnen"}
    };

    // Default constructor
    public RadnetBundle()
    {
        super();
    }

    public Object[][] getContents()
    {
        return contents;
    }
}
```

- Zeilenumbrüche wie in C/C++
- Platzhalter wie .NET

XML

```
<dokument><kapitel>Überschrift<absatz>Erster Satz. Zweiter Satz.</absatz>  
<absatz>Ein satz im <fett>zweiten Absatz.</fett></absatz></kapitel></dokument>
```

Überschrift

Erster Satz. Zweiter Satz.

Ein Satz im **zweiten Absatz.**

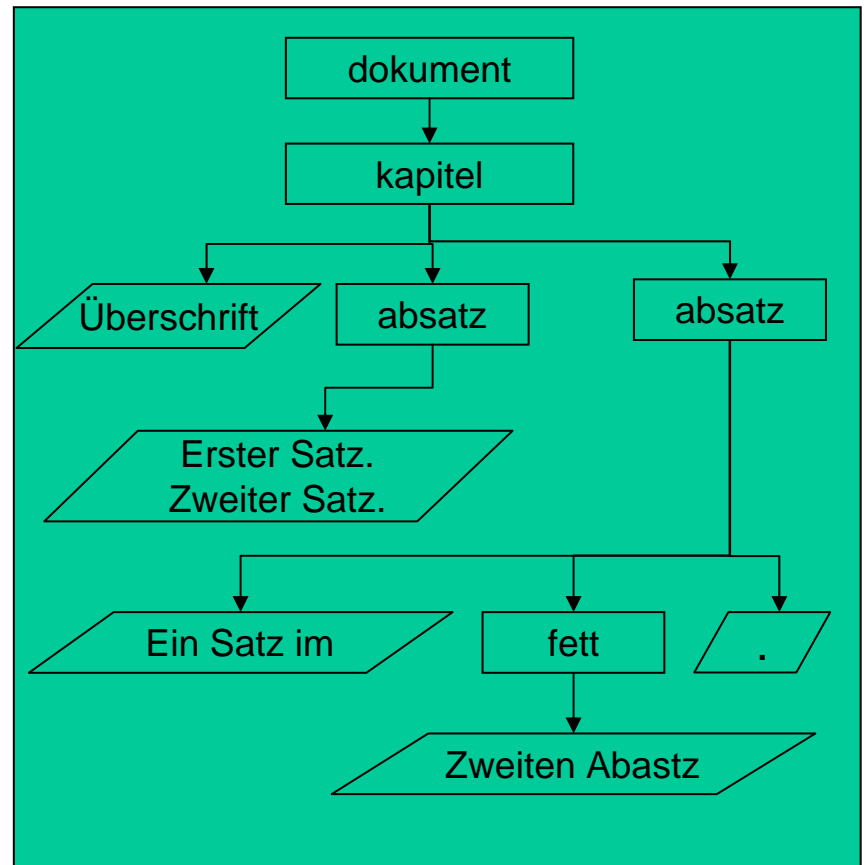

XML

```
<resources>  
  <string id="Dialog.Caption">Info about JavaSample</string>  
  <string id="Dialog.Label1">JavaSample 1.0</string>  
  <string id="Dialog.Label2">Copyright (C) 2005</string>  
  <string id="Dialog.OKButton">OK</string>  
</resources>
```

XML

```
<resources>
  <string id="Dialog.Caption">Info about JavaSample</string>
  <string id="Dialog.Label1">JavaSample 1.0</string>
  <string id="Dialog.Label2">Copyright (C) 2005</string>
  <string id="Dialog.OKButton">OK</string>
</resources>
```

```
<resources>
  <string <id>Dialog.Caption</id><data>Info about JavaSample</data></string>
  <string <id>Dialog.Label1</id><data>JavaSample 1.0</data></string>
  <string <id>Dialog.Label2</id><data>Copyright (C) 2005</data></string>
  <string <id>Dialog.OKButton</id><data>OK</data></string>
</resources>
```

```
<resources>
  <string id="Dialog.Caption" data="Info about JavaSample"</string>
  <string id="Dialog.Label1" data="JavaSample 1.0"</string>
  <string id="Dialog.Label2" data="Copyright (C) 2005"</string>
  <string id="Dialog.OKButton" data="OK"</string>
</resources>
```

```
<resources>
  <Dialog.Caption>Info about JavaSample</Dialog.Caption>
  <Dialog.Label1>JavaSample 1.0</Dialog.Label1>
  <Dialog.Label2>Copyright (C) 2005</Dialog.Label2>
  <Dialog.OKButton>OK</Dialog.OKButton>
</resources>
```

PO-Dateien

```
# wp-admin/post.php:771
#, php-format
msgid "<p>Raise your level to 1.</p>"
msgstr "<p>Erhöhe Deine Stufe auf 1.</p>"

#: utility/log.c:285 utility/log.c:304
#, c-format
msgid "similar messages found"
msgstr "ähnliche Meldungen gefunden"
```

- Die gleiche Datei kann unterschiedliche Kodierungen enthalten
- PO-Dateien haben keine ID
- PO-Dateien sind bilingual

```
01 <?xml version="1.0"?>
02 <xliff version='1.1'>
03 <file datatype='winres' source-language='en' target-language='de'>
04 <body>
05 <group id = '1' restype = 'menu' resname = '1'>
06 <trans-unit id = '1' restype = 'menupopup' style = '0x10' ts = '0'>
07 <source>&amp;File</source>
08 <target>&amp;Datei</target>
09 </trans-unit>
10 <group restype = 'popup'>
11 <trans-unit id = '2' resname = '9' restype = 'menuentry' ts = '1'>
12 <source>&amp;New</source>
13 </trans-unit>
14 <trans-unit id = '3' resname = '10' restype = 'menuentry' ts = '1'>
15 <source>&amp;Open...</source>
16 </trans-unit>
17 </group>
18 <trans-unit id = '11' restype = 'menupopup' style = '0x10' ts = '0'>
19 <source>&amp;Edit</source>
20 </trans-unit>
21 <group restype = 'popup'>
22 <trans-unit id = '12' resname = '25' restype = 'menuentry' ts = '1'>
23 <source>&amp;Undo Ctrl+Z</source>
24 </trans-unit>
25 </group>
26 </group>
27 </group>
28 <group id = '2' restype = 'dialog' coord = '#;#;90;64' font='MS Sans Serif;8;0'>
29 <trans-unit id = '30' restype = 'caption'>
30 <source>Notepad</source>
31 </trans-unit>
32 <trans-unit id = '31' resname = '2' restype = 'button' coord = '29;44;32;14'>
33 <source>Cancel</source>
34 </trans-unit>
35 <trans-unit id = '32' resname = '65535' restype = 'static' coord = '0;8;90;8'>
36 <source>Now Printing</source>
37 </trans-unit>
38 <trans-unit id = '33' resname = '20' restype = 'static' coord = '0;18;90;8'>
39 <source></source>
40 </trans-unit>
41 </group>
42 </body>
43 </file>
44 </xliff>
```

XLIFF 1

```
01 <?xml version="1.0"?>
02 <xliff version='1.1'>
03 <file datatype='winres' source-language='en' target-language='de'>
04 <body>
05 <group id = '1' restype = 'menu' resname = '1'>
06 <trans-unit id = '1' restype = 'menupopup' style = '0x10' ts = '0'>
07 <source>&amp;File</source>
08 <target>&amp;Datei</target>
09 </trans-unit>
10 <group restype = 'popup'>
11 <trans-unit id = '2' resname = '9' restype = 'menuentry' ts = '1'>
12 <source>&amp;New</source>
13 </trans-unit>
14 <trans-unit id = '3' resname = '10' restype = 'menuentry' ts = '1'>
15 <source>&amp;Open...</source>
16 </trans-unit>
17 </group>
18 <trans-unit id = '11' restype = 'menupopup' style = '0x10' ts = '0'>
19 <source>&amp;Edit</source>
20 </trans-unit>
21 <group restype = 'popup'>
22 <trans-unit id = '12' resname = '25' restype = 'menuentry' ts = '1'>
23 <source>&amp;Undo Ctrl+Z</source>
24 </trans-unit>
25 </group>
26 </group>
27 </group>
28 <group id = '2' restype = 'dialog' coord = '#;#;90;64' font='MS Sans Serif;8;0'>
29 <trans-unit id = '30' restype = 'caption'>
30 <source>Notepad</source>
31 </trans-unit>
32 <trans-unit id = '31' resname = '2' restype = 'button' coord = '29;44;32;14'>
33 <source>Cancel</source>
34 </trans-unit>
35 <trans-unit id = '32' resname = '65535' restype = 'static' coord = '0;8;90;8'>
36 <source>Now Printing</source>
37 </trans-unit>
38 <trans-unit id = '33' resname = '20' restype = 'static' coord = '0;18;90;8'>
39 <source></source>
40 </trans-unit>
41 </group>
42 </body>
43 </file>
44 </xliff>
```

XLIFF 1

```
01 <?xml version="1.0"?>
02 <xliff version='1.1'>
03 <file datatype='winres' source-language='en' target-language='de'>
04 <body>
05 <group id = '1' restype = 'menu' resname = '1'>
06 <trans-unit id = '1' restype = 'menupopup' style = '0x10' ts = '0'>
07 <source>&amp;File</source>
08 <target>&amp;Datei</target>
09 </trans-unit>
10 <group restype = 'popup'>
11 <trans-unit id = '2' resname = '9' restype = 'menuentry' ts = '1'>
12 <source>&amp;New</source>
13 </trans-unit>
14 <trans-unit id = '3' resname = '10' restype = 'menuentry' ts = '1'>
15 <source>&amp;Open...</source>
16 </trans-unit>
17 </group>
18 <trans-unit id = '11' restype = 'menupopup' style = '0x10' ts = '0'>
19 <source>&amp;Edit</source>
20 </trans-unit>
21 <group restype = 'popup'>
22 <trans-unit id = '12' resname = '25' restype = 'menuentry' ts = '1'>
23 <source>&amp;Undo Ctrl+Z</source>
24 </trans-unit>
25 </group>
26 </group>
27 </group>
28 <group id = '2' restype = 'dialog' coord = '#;#;90;64' font='MS Sans Serif;8;0'>
29 <trans-unit id = '30' restype = 'caption'>
30 <source>Notepad</source>
31 </trans-unit>
32 <trans-unit id = '31' resname = '2' restype = 'button' coord = '29;44;32;14'>
33 <source>Cancel</source>
34 </trans-unit>
35 <trans-unit id = '32' resname = '65535' restype = 'static' coord = '0;8;90;8'>
36 <source>Now Printing</source>
37 </trans-unit>
38 <trans-unit id = '33' resname = '20' restype = 'static' coord = '0;18;90;8'>
39 <source></source>
40 </trans-unit>
41 </group>
42 </body>
43 </file>
44 </xliff>
```

XLIFF 1

XLIFF 2

```
01 <?xml version="1.0"?>
02 <xliff version='1.1'>
03   <file datatype='winres' source-language='en' target-language='de'>
04     <body>
05       <trans-unit id = '1'>
06         <source>&Options</source>
07         <alt-trans>
08           <target>&amp;Extras</target>
09           <target>&amp;Optionen</target>
10         </alt-trans>
11       </trans-unit>
12     <trans-unit id = '2', translate = 'no'>
13       <source>Copyright XYZ (C) 2004</source>
14     </trans-unit>
15     <trans-unit id = '3'>
16       <source>Find</source>
17       <note>Do not translate as Suchen</note>
18     </trans-unit>
19   </body>
20 </file>
21 </xliff>
```

XLIFF 2

```
01 <?xml version="1.0"?>
02 <xliff version='1.1'>
03   <file datatype='winres' source-language='en' target-language='de'>
04     <body>
05       <trans-unit id = '1'>
06         <source>&Options</source>
07         <alt-trans>
08           <target>&Extras</target>
09           <target>&Optionen</target>
10         </alt-trans>
11       </trans-unit>
12       <trans-unit id = '2', translate = 'no'>
13         <source>Copyright XYZ (C) 2004</source>
14       </trans-unit>
15       <trans-unit id = '3'>
16         <source>Find</source>
17         <note>Do not translate as Suchen</note>
18       </trans-unit>
19     </body>
20   </file>
21 </xliff>
```

XLIFF 2

```
01 <?xml version="1.0"?>
02 <xliff version='1.1'>
03   <file datatype='winres' source-language='en' target-language='de'>
04     <body>
05       <trans-unit id = '1'>
06         <source>&Options</source>
07         <alt-trans>
08           <target>&Extras</target>
09           <target>&Optionen</target>
10         </alt-trans>
11       </trans-unit>
12       <trans-unit id = '2', translate = 'no'>
13         <source>Copyright XYZ (C) 2004</source>
14       </trans-unit>
15       <trans-unit id = '3'>
16         <source>Find</source>
17         <note>Do not translate as Suchen</note>
18       </trans-unit>
19     </body>
20   </file>
21 </xliff>
```